

SOT-23 Plastic-Encapsulate MOSFETS

P-Channel 8-V(D-S) MOSFET

FEATURE

TrenchFET Power MOSFET

APPLICATIONS

- Load Switch for Portable Devices
- DC/DC Converter

MARKING: 2305

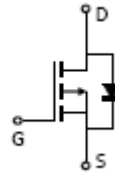
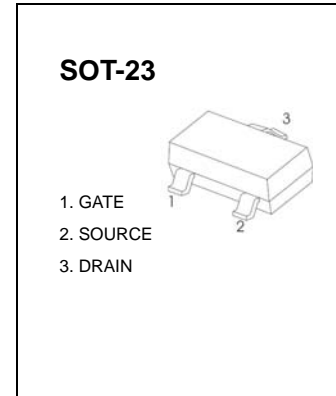

Maximum ratings ($T_a=25^\circ\text{C}$ unless otherwise noted)

Parameter	Symbol	Value	Unit
Drain-Source Voltage	V_{DS}	-20	V
Gate-Source Voltage	V_{GS}	± 8	
Continuous Drain Current	I_D	-4.1	A
Continuous Source-Drain Diode Current	I_S	-0.8	
Maximum Power Dissipation	P_D	0.35	W
Thermal Resistance from Junction to Ambient($t \leq 10s$)	$R_{\theta JA}$	357	$^\circ\text{C/W}$
Junction Temperature	T_J	150	$^\circ\text{C}$
Storage Temperature	T_{STG}	-50 ~+150	

Electrical characteristics (T_a=25°C unless otherwise noted)

Parameter	Symbol	Test Condition	Min	Typ	Max	Units
Static						
Drain-source breakdown voltage	V _{(BR)DSS}	V _{GS} = 0V, I _D = -250μA	-20			V
Gate-source threshold voltage	V _{GS(th)}	V _{DS} = V _{GS} , I _D = -250μA	-0.5		-0.9	
Gate-source leakage	I _{GSS}	V _{DS} = 0V, V _{GS} = ±8V			±100	nA
Zero gate voltage drain current	I _{DSS}	V _{DS} = -16V, V _{GS} = 0V			-1	μA
Drain-source on-state resistance ^a	R _{DS(on)}	V _{GS} = -4.5V, I _D = -3.5A			0.045	Ω
		V _{GS} = -2.5V, I _D = -3A			0.060	
		V _{GS} = -1.8V, I _D = -2.0A			0.090	
Forward transconductance ^a	g _{fs}	V _{DS} = -5V, I _D = -4.1A	6			S
Dynamic						
Input capacitance ^{b,c}	C _{iSS}	V _{DS} = -4V, V _{GS} = 0V, f = 1MHz		740		pF
Output capacitance ^{b,c}	C _{oSS}			290		
Reverse transfer capacitance ^{b,c}	C _{rSS}			190		
Total gate charge ^b	Q _g	V _{DS} = -4V, V _{GS} = -4.5V, I _D = -4.1A		7.8	15	nC
		V _{DS} = -4V, V _{GS} = -2.5V, I _D = -4.1A		4.5	9	
Gate-source charge ^b	Q _{gs}	V _{DS} = -4V, V _{GS} = -2.5V, I _D = -4.1A		1.2		
Gate-drain charge ^b	Q _{gd}			1.6		
Gate resistance ^{b,c}	R _g	f = 1MHz	1.4	7	14	Ω
Turn-on delay time ^{b,c}	t _{d(on)}	V _{DD} = -4V, R _L = 1.2Ω, I _D ≈ -3.3A, V _{GEN} = -4.5V, R _g = 1Ω		13	20	ns
Rise time ^{b,c}	t _r			35	53	
Turn-off Delay time ^{b,c}	t _{d(off)}			32	48	
Fall time ^{b,c}	t _f			10	20	
Turn-on delay time ^{b,c}	t _{d(on)}	V _{DD} = -4V, R _L = 1.2Ω, I _D ≈ -3.3A, V _{GEN} = -8V, R _g = 1Ω		5	10	
Rise time ^{b,c}	t _r			11	17	
Turn-off delay time ^{b,c}	t _{d(off)}			22	33	
Fall time ^{b,c}	t _f			16	24	
Drain-source body diode characteristics						
Continuous source-drain diode current	I _S	T _C = 25°C			-1.4	A
Pulse diode forward current ^a	I _{SM}				-10	
Body diode voltage	V _{SD}	I _F = -3.3A		-0.8	-1.2	V

Note :

- a. Pulse Test ; Pulse Width ≤ 300μs, Duty Cycle ≤ 2%.
- b. Guaranteed by design, not subject to production testing.
- c. These parameters have no way to verify.

Typical Characteristics

BC2305

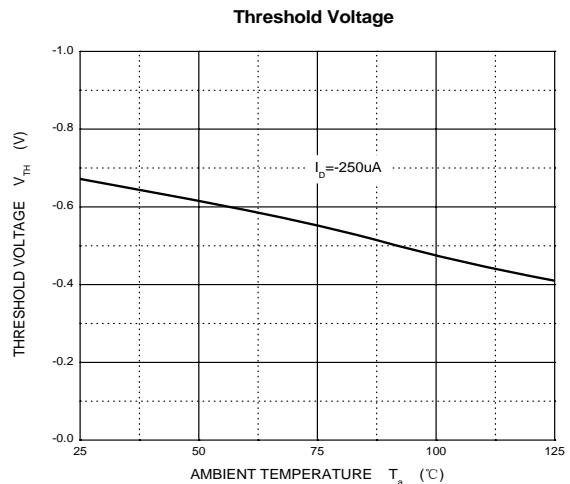
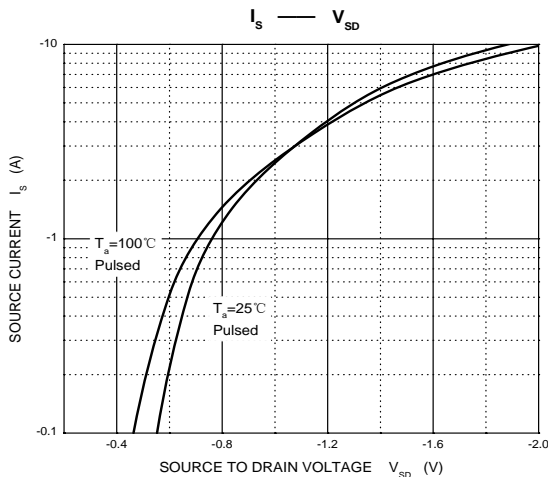
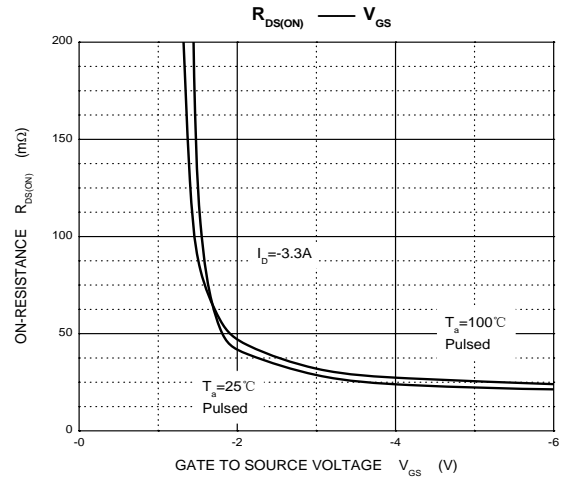
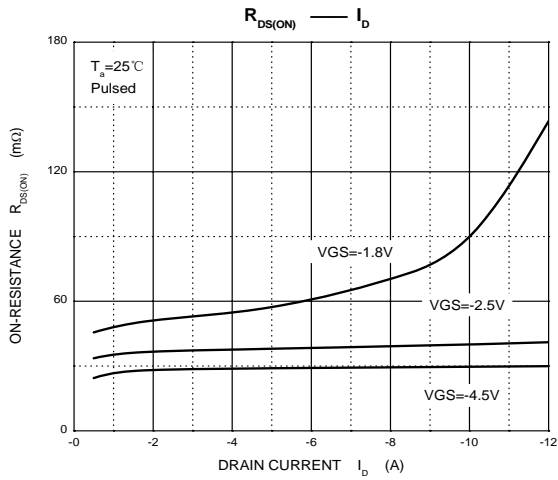
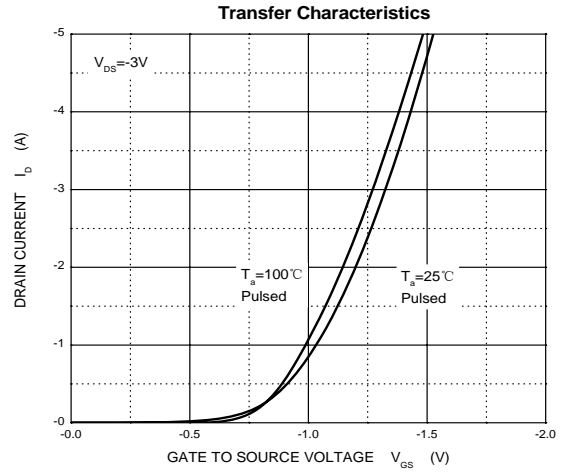
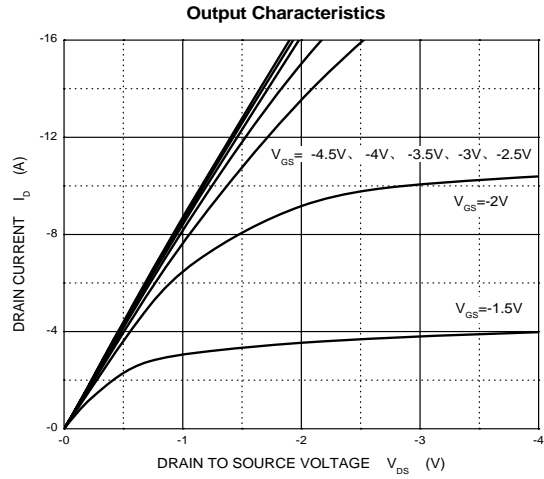

PACKAGE OUTLINE

Plastic surface mounted package; 3 leads

SOT-23

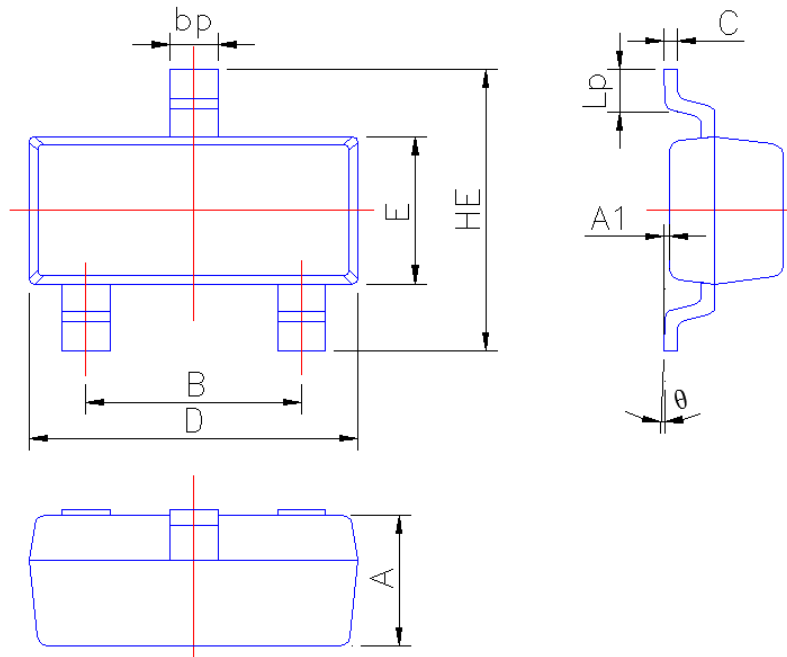

Symbol	Dimension in Millimeters	
	Min	Max
A	0.90	1.10
A1	0.013	0.100
B	1.80	2.00
bp	0.35	0.50
C	0.09	0.150
D	2.80	3.00
E	1.20	1.40
HE	2.20	2.80
Lp	0.20	0.50
θ	0°	5°