

SOT23-3L Plastic-Encapsulate MOSFETS

N-Channel Enhancement Mode Field Effect Transistor

$V_{(BR)DSS}$	$R_{DS(on)MAX}$	I_D
30V	30mΩ@ 10V	5.8A
	42mΩ@4.5V	

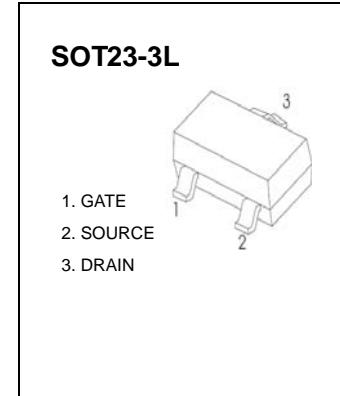

DESCRIPTION

The BC3404 use advanced trench technology to provide excellent $R_{DS(ON)}$ and low gate charge. This device is suitable for use as a load switch or in PWM applications. The source leads are separated to allow a Kelvin connection to the source, which may be used to bypass the source inductance.

MARKING

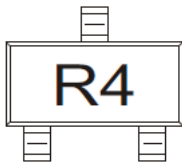

Equivalent Circuit

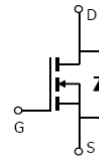

Maximum ratings ($T_a=25^\circ\text{C}$ unless otherwise noted)

Parameter	Symbol	Value	Unit
Drain-source voltage	V_{DS}	30	V
Gate-source voltage	V_{GS}	± 20	V
Continuous drain current ($t \leq 10\text{s}$)	I_D	5.8	A
Pulsed drain current *	I_{DM}	30	A
Thermal resistance from junction to ambient	$R_{\theta JA}$	357	$^\circ\text{C}/\text{W}$
Junction temperature	T_J	150	$^\circ\text{C}$
Storage temperature	T_{stg}	-55~ 150	$^\circ\text{C}$

* Repetitive rating : Pulse width limited by maximum junction temperature.

MOSFET ELECTRICAL CHARACTERISTICS

$T_a=25\text{ }^\circ\text{C}$ unless otherwise specified

Parameter	Symbol	Test Condition	Min	Typ	Max	Units
STATIC PARAMETERS						
Drain-source breakdown voltage	$V_{(BR)DSS}$	$V_{GS} = 0V, I_D = 250\mu A$	30			V
Zero gate voltage drain current	I_{DSS}	$V_{DS} = 30V, V_{GS} = 0V$			1	μA
Gate-body leakage current	I_{GSS}	$V_{GS} = \pm 20V, V_{DS} = 0V$			± 100	nA
Gate threshold voltage	$V_{GS(th)}$	$V_{DS} = V_{GS}, I_D = 250\mu A$	1		3	V
Drain-source on-resistance (note 1)	$R_{DS(on)}$	$V_{GS} = 10V, I_D = 5.8A$			30	m Ω
		$V_{GS} = 4.5V, I_D = 4.8A$			42	m Ω
Forward tranconductance (note 1)	g_{FS}	$V_{DS} = 5V, I_D = 5.8A$	5			S
Diode forward voltage	V_{SD}	$I_S = 1A$			1	V
DYNAMIC PARAMETERS (note 2)						
Input capacitance	C_{iss}	$V_{DS} = 15V, V_{GS} = 0V, f = 1MHz$			820	pF
Output capacitance	C_{oss}			118		pF
Reverse transfer capacitance	C_{rss}			85		pF
Gate resistance	R_g	$V_{DS} = 0V, V_{GS} = 0V, f = 1MHz$			1.5	Ω
SWITCHING PARAMETERS (note 2)						
Turn-on delay time	$t_{d(on)}$	$V_{GS} = 10V, V_{DS} = 15V,$ $R_L = 2.6\Omega, R_{GEN} = 3\Omega$			6.5	ns
Turn-on rise time	t_r			3.1		ns
Turn-off delay time	$t_{d(off)}$			15.1		ns
Turn-off fall time	t_f			2.7		ns

Note :

1. Pulse Test : Pulse width $\leq 300\mu s$, duty cycle $\leq 0.5\%$.
2. These parameters have no way to verify.

Typical Characteristics

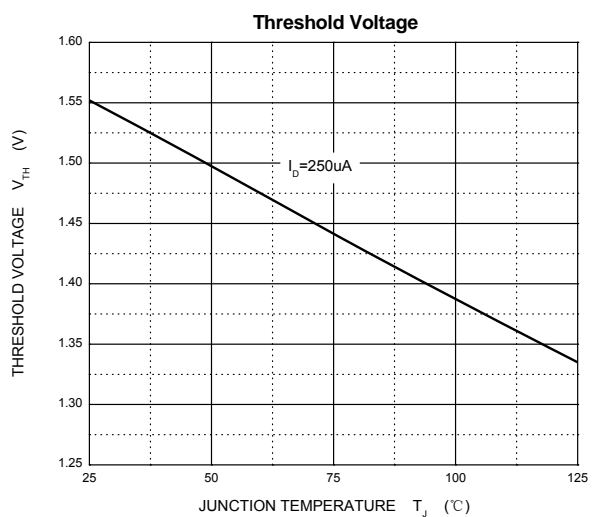
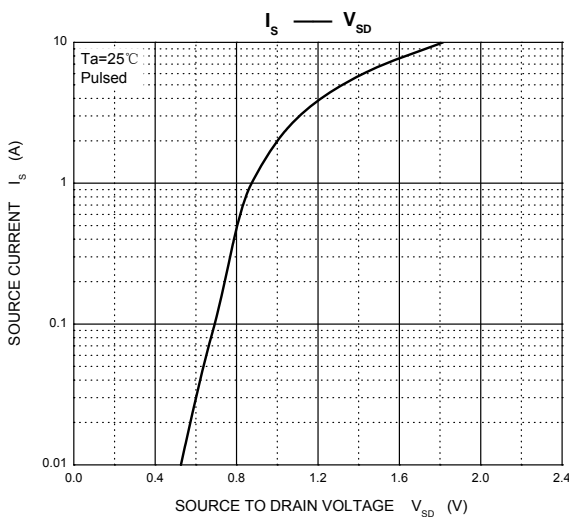
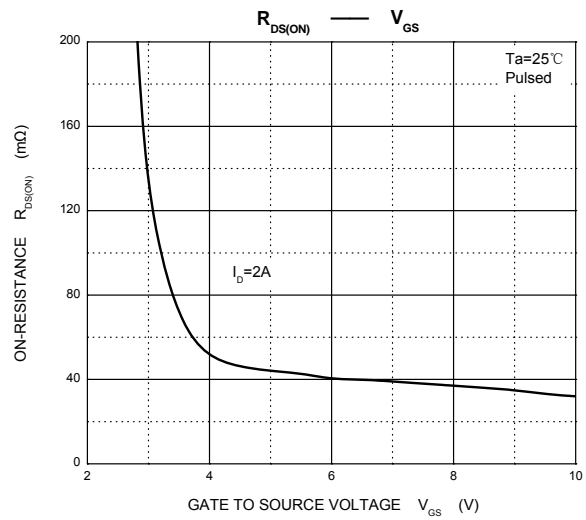
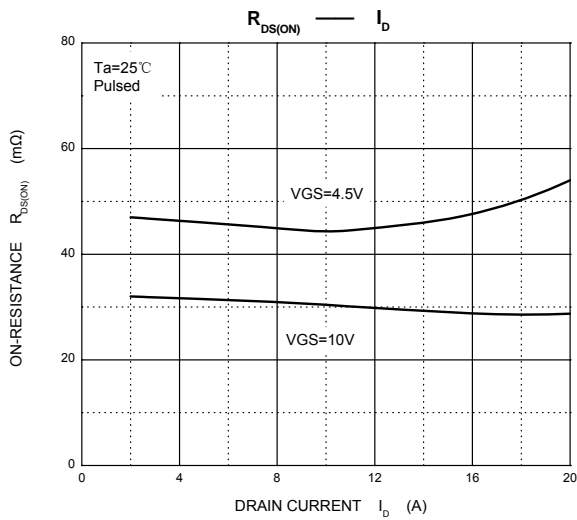
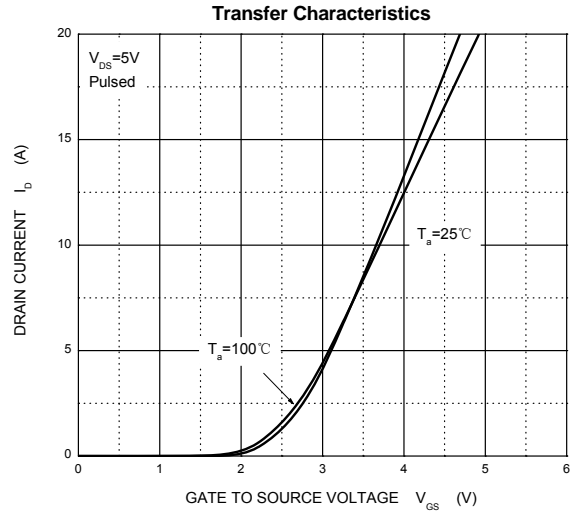
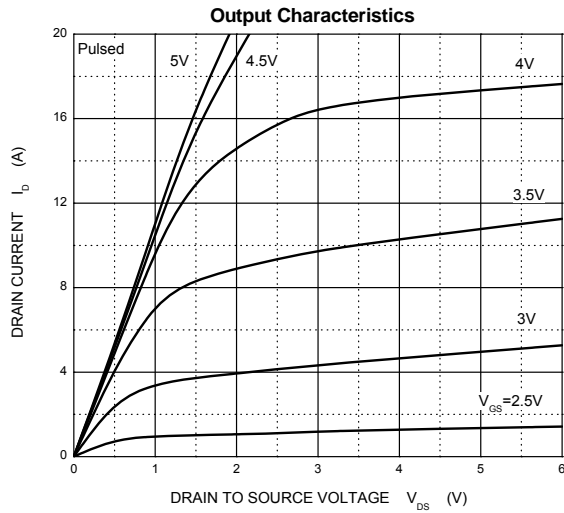



SOT23-3L Package outline dimensions

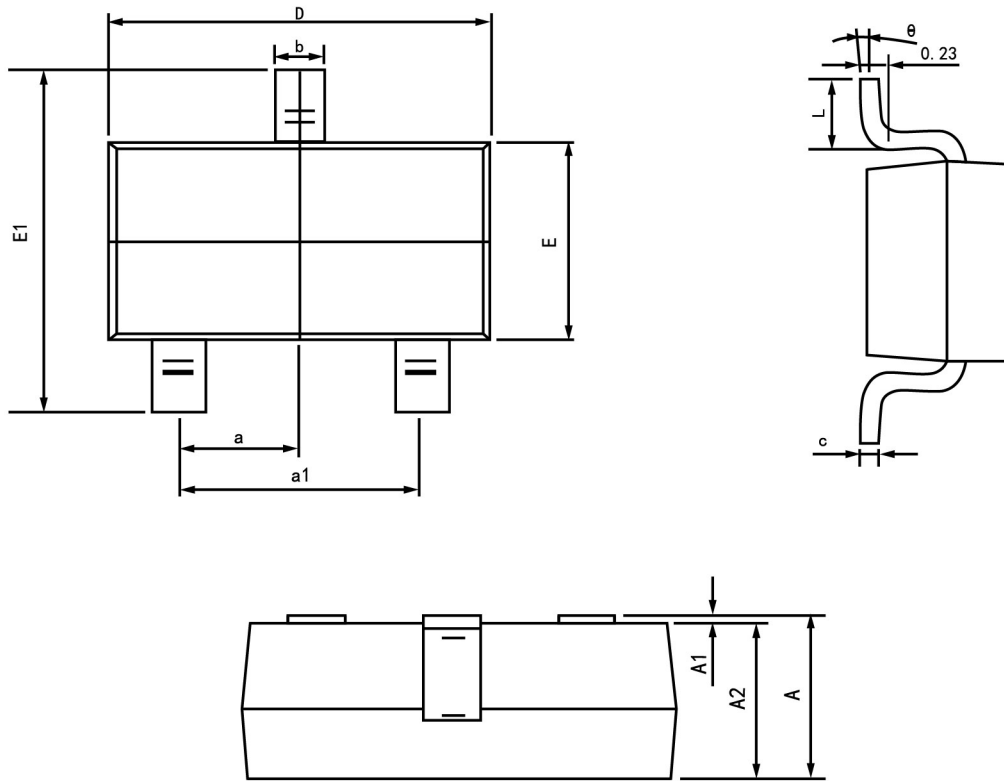

Symbol	Dimension in Millimeters	
	Min	Max
A	1.050	1.250
A1	0.000	0.100
A2	1.050	1.150
b	0.300	0.500
c	0.100	0.200
D	2.820	3.020
E	1.500	1.700
E1	2.650	2.950
e	0.950 (Basic)	
e1	1.800	2.000
L	0.300	0.600
theta	0°	8°