

Plastic-Encapsulate MOSFETS

P-Channel 20-V(D-S) MOSFET

FEATURE

TrenchFET Power MOSFET

APPLICATIONS

- Load Switch for Portable Devices
- DC/DC Converter

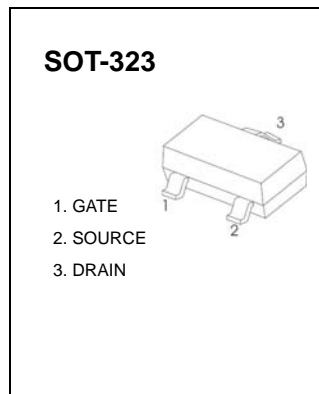

MARKING: 2301

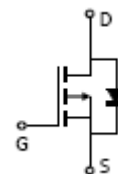

Maximum ratings ($T_a=25^{\circ}\text{C}$ unless otherwise noted)

Parameter	Symbol	Value	Unit
Drain-Source Voltage	V_{DS}	-20	V
Gate-Source Voltage	V_{GS}	± 8	
Continuous Drain Current	I_D	-2.1	A
Pulsed Drain Current	I_{DM}	-4.8	
Continuous Source-Drain Diode Current	I_S	-0.72	
Maximum Power Dissipation	P_D	0.35	W
Thermal Resistance from Junction to Ambient($t \leq 5s$)	$R_{\theta JA}$	357	$^{\circ}\text{C}/\text{W}$
Junction Temperature	T_J	150	$^{\circ}\text{C}$
Storage Temperature	T_{stg}	-55 ~+150	

Electrical characteristics (T_a=25°C unless otherwise noted)

Parameter	Symbol	Test Condition	Min	Typ	Max	Units
Static						
Drain-source breakdown voltage	V _{(BR)DSS}	V _{GS} = 0V, I _D = -250μA	-20			V
Gate-source threshold voltage	V _{GS(th)}	V _{DS} = V _{GS} , I _D = -250μA	-0.4		-1	
Gate-source leakage	I _{GSS}	V _{DS} = 0V, V _{GS} = ±8V			±100	nA
Zero gate voltage drain current	I _{DSS}	V _{DS} = -20V, V _{GS} = 0V			-1	μA
Drain-source on-state resistance ^a	R _{DS(on)}	V _{GS} = -4.5V, I _D = -1A		0.090	0.120	Ω
		V _{GS} = -2.5V, I _D = -0.5A		0.110	0.170	
Forward transconductance ^a	g _{fs}	V _{DS} = -5V, I _D = -1.8A		6.5		S
Dynamic^b						
Input capacitance	C _{iss}	V _{DS} = -10V, V _{GS} = 0V, f = 1MHz		405		pF
Output capacitance	C _{oss}			75		
Reverse transfer capacitance	C _{rss}			55		
Total gate charge	Q _g	V _{DS} = -10V, V _{GS} = -4.5V, I _D = -3A		5.5	10	nC
				3.3	6	
Gate-source charge	Q _{gs}	V _{DS} = -10V, V _{GS} = -2.5V, I _D = -3A		0.7		
Gate-drain charge	Q _{gd}			1.3		
Gate resistance	R _g	f = 1MHz		6.0		Ω
Turn-on delay time	t _{d(on)}	V _{DD} = -10V, R _L = 10Ω, I _D = -1A, V _{GEN} = -4.5V, R _g = 1Ω		11	20	ns
Rise time	t _r			35	60	
Turn-off delay time	t _{d(off)}			30	50	
Fall time	t _f			10	20	
Drain-source body diode characteristics						
Continuous source-drain diode current	I _S	T _C = 25°C			-1.3	A
Pulse diode forward current ^a	I _{SM}				-10	
Body diode voltage	V _{SD}	I _S = -0.7A		-0.8	-1.2	V

Notes :

- a. Pulse Test : Pulse Width < 300μs, Duty Cycle ≤2%.
- b. Guaranteed by design, not subject to production testing.

Typical Characteristics

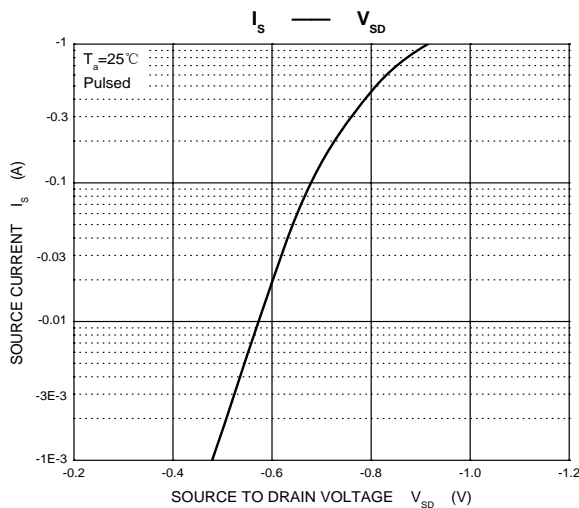
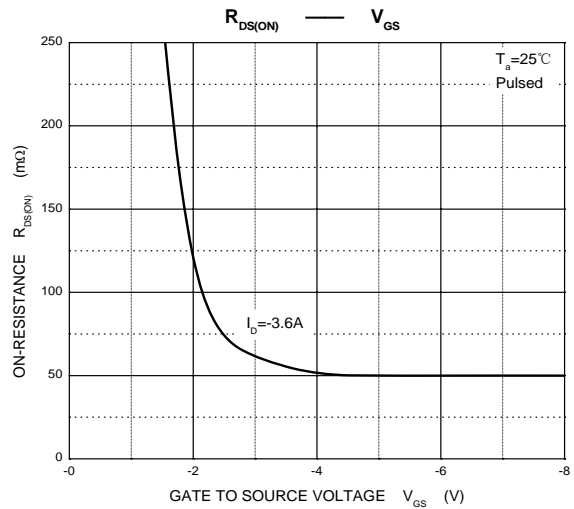
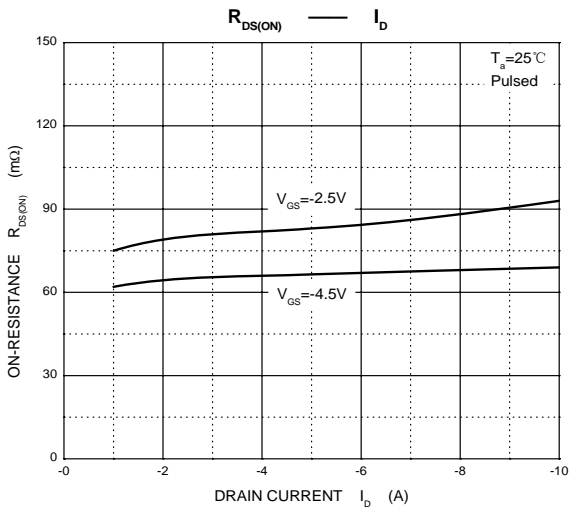
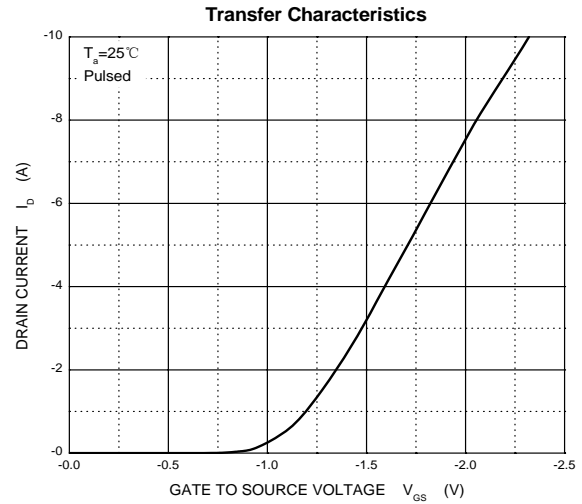
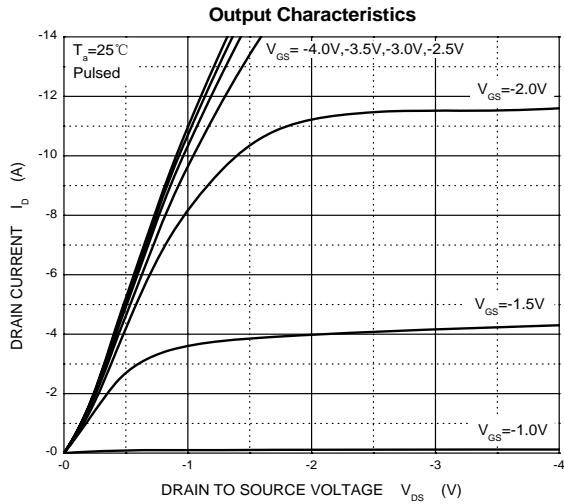

SOT-323 Package Outline Dimensions

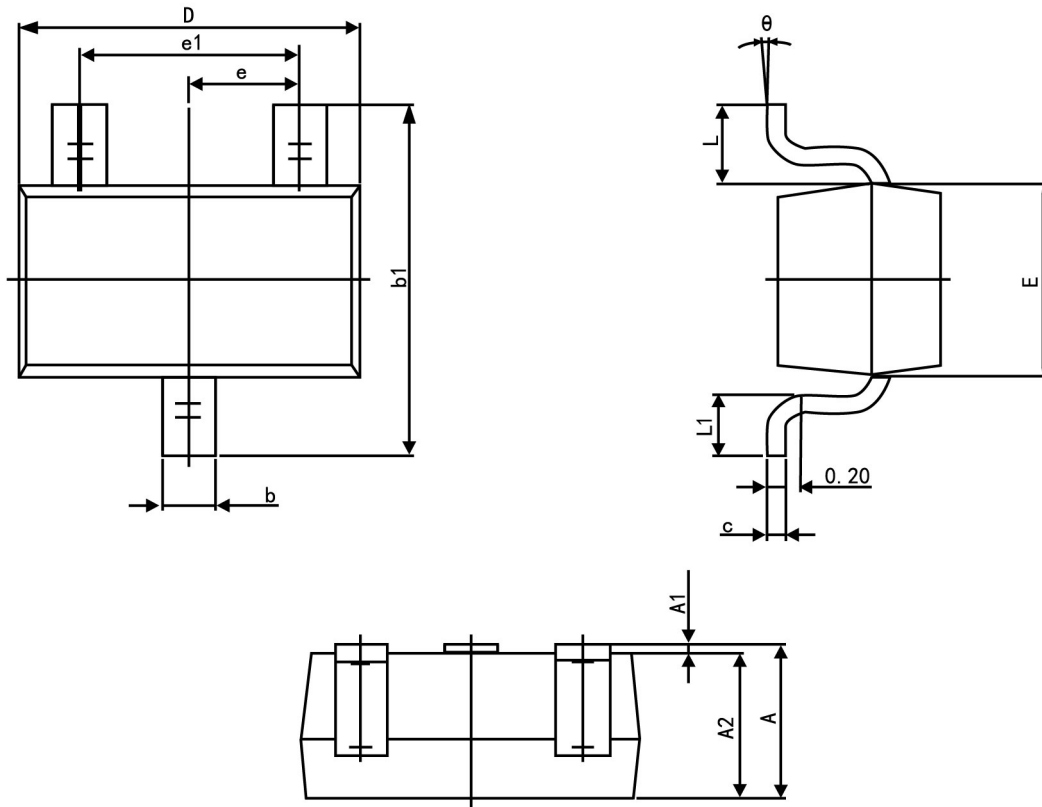

Symbol	Dimension in Millimeters	
	Min	Max
A	0.900	1.100
A1	0.000	0.100
A2	0.900	1.000
b	0.200	0.400
c	0.080	0.150
D	2.000	2.200
E	1.150	1.350
E1	2.150	2.450
e	0.650 TYP.	
e1	1.200	1.400
L	0.525 REF.	
L1	0.260	0.460
θ	0°	8°